







**MADISON Bath shower set for bath rim or tile edge installation - Brushed Platinum**

MADISON

ST 030 100 3370



- spout: circular, air-enriched flow
- max. spout flow rate 23 l/min
- Hand shower: COMPACT RAIN, max. flow rate 6.8 l/min (at 3 bar)
- complete hand shower set with anti-scale system
- 225mm projection
- automatic bath/shower diverter
- height of mixer 185 mm
- height up to aerator 140 mm
- hole diameter valve 32 mm
- hole diameter spout 32 mm
- hole diameter for complete hand shower set 32 mm
- rosette for spout Ø 70mm
- rosette for complete hand shower set Ø 60mm
- rosette for deck valve Ø 60mm
- metal shower hose 1750mm with integrated anti-twist protection

	Brushed Platinum	ST 030 100 3370-06
	Chrome	ST 030 100 3370-00
	Platinum	ST 030 100 3370-08
	Durabrand (23kt Gold)	ST 030 100 3370-09
	Brushed Durabrand (23kt Gold)	ST 030 100 3370-28
	Brushed Dark Platinum	ST 030 100 3370-99

**Individual components of this set**

You need the following components for this set

1x 27 502 370-06



2x 11 170 370-06





MADISON Bath shower set for bath rim or tile edge installation - Brushed  
Platinum

---

MADISON

ST 030 100 3370

**MADISON Bath shower set for bath rim or tile edge installation - Brushed Platinum**







MADISON

ST 030 100 3370



- 225mm projection
- complete hand shower set: normal flow
- spout: circular, air-enriched flow
- complete hand shower set with anti-scale system
- automatic bath/shower diverter
- height of mixer 185 mm
- height up to aerator 140 mm
- hole diameter valve 32 mm
- hole diameter spout 32 mm
- hole diameter for complete hand shower set 32 mm
- rosette for spout Ø 70mm
- rosette for complete hand shower set Ø 60mm
- rosette for deck valve Ø 60mm
- metal shower hose 1750mm with integrated anti-twist protection
- max. spout flow rate 23 l/min
- max. flow for complete hand shower set 6.8 l/min

Intrinsic protection against back flow.

	Brushed Platinum	27 502 370-06
	Chrome	27 502 370-00
	Platinum	27 502 370-08
	Durabass (23kt Gold)	27 502 370-09
	Brushed Durabass (23kt Gold)	27 502 370-28
	Brushed Dark Platinum	27 502 370-99

**Recommended miscellaneous**



**Perfecto installation kit - 12 614 970 90**

ST 030 100 3370  
mm [inches]  
1:10

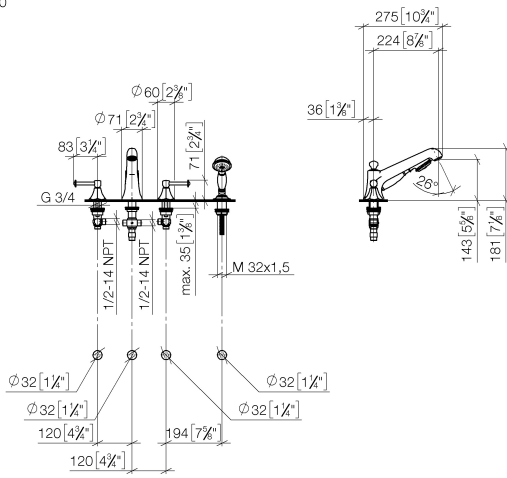

**Flow rate chart**

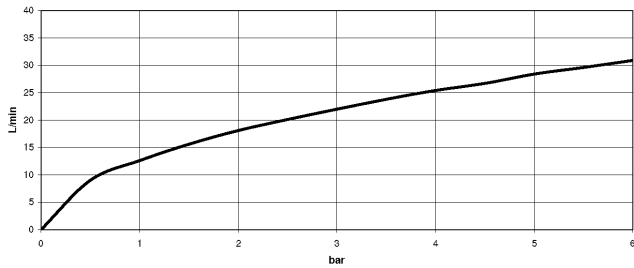

**Certificates**

LGA\_8028.

Belgaqua\_21-380-  
27\_4.

ST 030 100 3370

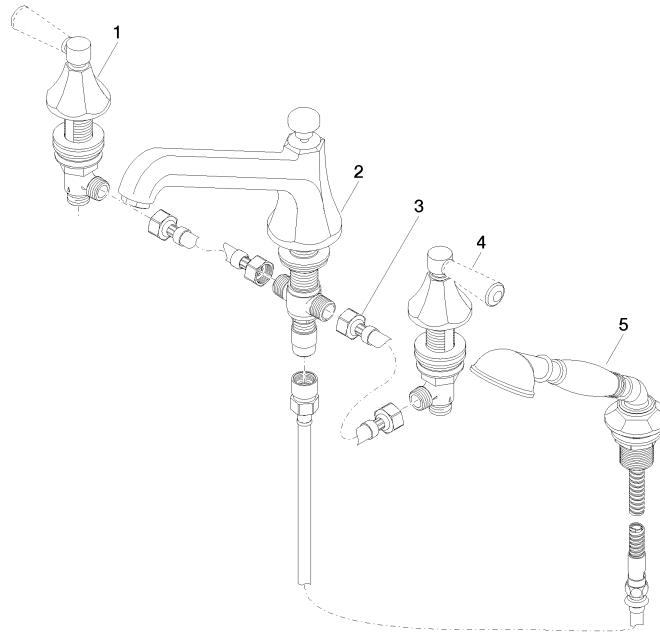

**Spare parts list**

No.	Item Number	Name	Quantity used	Delivery time
1	20 000 370-06	side panel	1	60
2	13 502 380-06	spout	1	60
3	12 502 970 90	High pressure hose 1/2" x 1/2" x 400 mm -	2	2
4	20 000 371-06	side panel	1	60
5	27 703 370-06	shower set	1	60

**MADISON Bath shower set for bath rim or tile edge installation - Brushed  
Platinum**









MADISON

ST 030 100 3370



- for basin fittings

NOTE: Mixers are supplied without lever inserts.  
Please order the lever inserts separately!

	Brushed Platinum	11 170 370-06
	Chrome	11 170 370-00
	Gold (23.9kt)	11 170 370-01
	Platinum	11 170 370-08
	Durabrand (23kt Gold)	11 170 370-09
	white	11 170 370-12
	black	11 170 370-13
	Brushed Durabrand (23kt Gold)	11 170 370-28
	Brushed Dark Platinum	11 170 370-99



MADISON Bath shower set for bath rim or tile edge installation - Brushed  
Platinum

---

MADISON

ST 030 100 3370

ST 030 100 3370

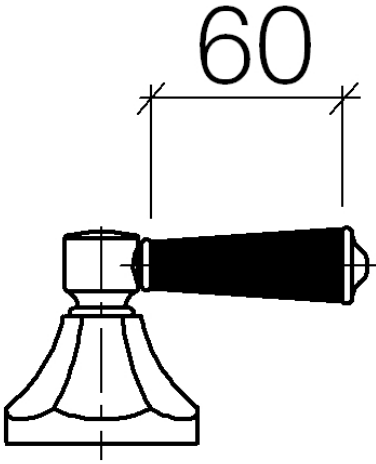





MADISON Bath shower set for bath rim or tile edge installation - Brushed  
Platinum

---

MADISON

ST 030 100 3370

MADISON Bath shower set for bath rim or tile edge installation - Brushed  
Platinum

---

MADISON

ST 030 100 3370  
Parts for other  
finishes can be found  
here: [Chrome](#)

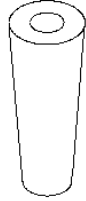



MADISON Bath shower set for bath rim or tile edge installation - Brushed  
Platinum

---

MADISON

ST 030 100 3370